

Range (ATO-24G6B)

Standard Features

- ◆ Stainless steel front, back, sides, kick plate including back guard and high shelf
- ◆ Heavy duty lift off cast iron burners rated at 25,000 BTU/hr
- ◆ 12"×12"cast iron top grates
- ◆ Oven burner rated at 27,000 BTU/hr
- ◆ Oven pilot with 100% safety shut off
- ◆ Multiple position oven rack guides
- ◆ One chrome rack per oven
- ◆ Stainless steel tubing for burners and pilots
- ◆ 3/4" thick polished steel griddle plate
- ◆ 1 year parts and labor



ATO-24G6B



Specifications

Gas type	Intake-tube Pressure (in.W.C.)	Ignition Way	Burner name	Nozzle No	Per BTU B.T.U./h	Burners QTY (pcs)	Total BTU B.T.U./h	Oven QTY	Oven size(inch)	Griddle working area (inch)	Hot plates working area (inch)	Valve Types	Temp. Control	Net Weight (LBS)	Exterior Size(inch)	
NG	5	Manually	Hot plates	NG45	25000	6	252000	2	26 1/2 *26*14	24*20 5/8	6pcs 11 4/5*11 4/5	Pilot light	Only the oven	734	60*31 *56 3/8	
			Griddle	U-SHAPE	NG42	27000										1
				I-SHAPE	NG45	21000										1
			Oven	NG39	27000	2										
LP	10	Manually	Hot plates	LP54	23000	6	240000	2	26 1/2 *26*14	24*20 5/8	6pcs 11 4/5*11 4/5	Pilot light	Only the oven	734	60*31 *56 3/8	
			Griddle	U-SHAPE	LP52	27000										1
				I-SHAPE	LP54	21000										1
			Oven	LP52	27000	2										



1 YEAR PARTS AND LABOR WARRANTY



Conforms to ANSI STD 283.11b-2009(2011)
 Certified to CSA STD 1.9b-2009(2011)
 Conforms to NSF/ANSI STD.4

Plan View

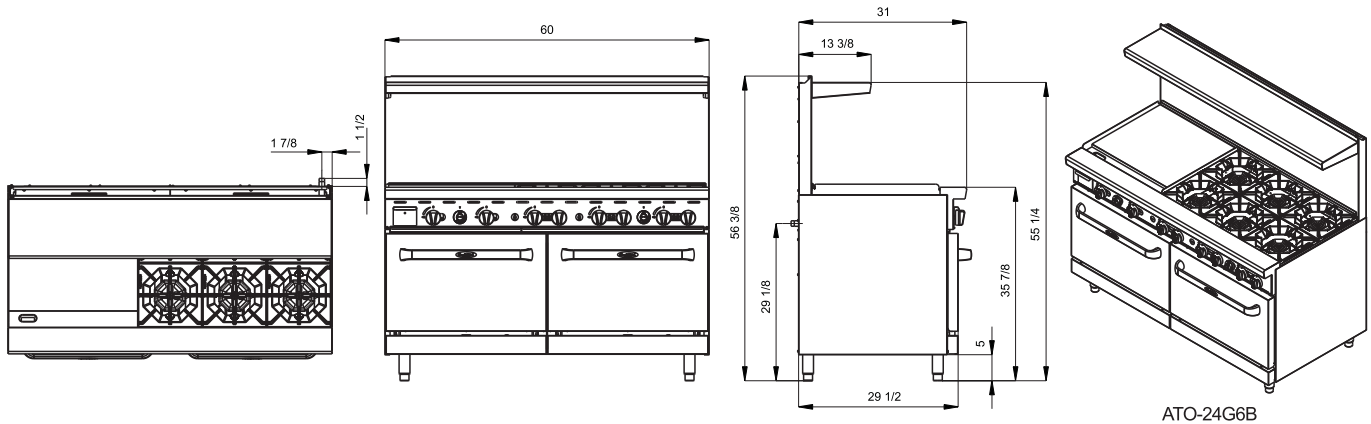

Terms and Conditions

1 YEAR WARRANTY

All claims for parts or labor must be made directly to Atosa. All claims must include: model number of the unit, serial number, proof of purchase, date of installation, and all pertinent information supporting the alleged defect. Failure to comply with warranty policies will result in voiding claims.

Atosa warrants all new gas components to be free from defects in materials or workmanship. Atosa's obligation under this warranty is limited to a period of 1 year from the original installation. All parts covered under this warranty that are defective within 1 year of the original installation are limited to repair or replacement (Including labor charges, of defective parts or assemblies) The labor warranty shall include standard straight time labor charges only and reasonable travel time, as determined by Atosa.

NO CONSEQUENTIAL DAMAGES: ATOSA IS NOT RESPONSIBLE FOR ECONOMIC LOSS; PROFIT LOSS; OR SPECIAL, INDIRECT, OR CONSEQUENTIAL DAMAGES, INCLUDING WITHOUT LIMITATION, LOSSES, OR DAMAGES ARISING FROM FOOD OR PRODUCT SPOILAGE, REGARDLESS OF WHETHER OR NOT THEY RESULT FROM REFRIGERATION FAILURE.

WARRANTY IS NOT TRANSFERABLE: This warranty is not assignable and applies only in favor of the original purchaser/user to whom delivered. ANY SUCH ASSIGNMENT OR TRANSFER SHALL VOID THE WARRANTIES HEREIN AND SHALL VOID ALL WARRANTIES, EXPRESS OR IMPLIED, INCLUDING ANY WARRANTY OF MERCHANTABILITY OR LABOR COVERAGE FOR COMPONENT FAILURE OR OTHER THE WARRANTY PACKET PROVIDED WITH THE UNIT.

ALTERATION, NEGLIGENCE, ABUSE, MISUSE, ACCIDENT, DAMAGE DURING TRANSIT OR INSTALLATION, FIRE, FLOOD, OR ACTS OF GOD: Atosa is not responsible for the repair or replacement of any parts that are determined to have been subjected after the date of manufacture to alteration, neglect, abuse, misuse, accident, damage during transit or installation, fire, flood, or acts of God.

WHAT IS WARRANTED AND FOR HOW LONG:

The Product's cast-iron grates, stainless steel radiants, and briquettes are warranted not to fail as a result of defects in materials or workmanship in normal use for a period of one year from the date of purchase. Atosa agrees to repair or replace, at its option, the above warranted parts or items that fails due to defects in materials or workmanship during the warranted period. To obtain warranty service, the Purchaser must contact Atosa toll free (855) 855-0399

THE ONE YEAR PARTS & LABOR WARRANTY ARE AS DESCRIBED ABOVE. THESE WARRANTIES ARE EXCLUSIVE AND IN LIEU OF ALL OTHER WARRANTIES, INCLUDING IMPLIED WARRANTY AND MERCHANTABILITY OR FITNESS FOR A PARTICULAR PURPOSE. THERE ARE NO WARRANTIES WHICH EXTEND BEYOND THE DESCRIPTION ON THE FACE HEREOF.

Outside U.S. and Canada: This warranty does not apply to areas outside the continent of the United States. Atosa is not responsible for any warranty claims made on products sold or used in such areas.

In some cases, a 25% restocking fee may be charged to a buyer for returned items.